

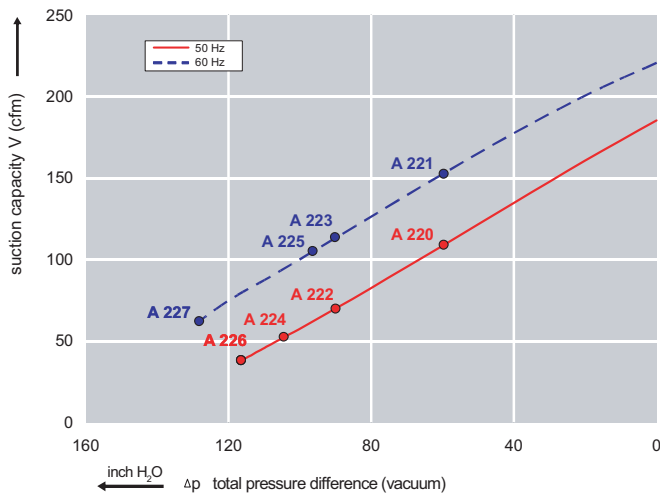

Features:

- Cooler running, outboard bearing provides maintenance-free operation
- Environmentally friendly oil-free technology
- Extremely quiet operation
- All motors are standard TEFC with Class F insulation, UL recognized, CE Compliant
Explosion-Proof motors available
- Custom construction blowers are available
- Rugged die cast aluminum construction

Performance curve for Vacuum pump



Performance curve for Compressor

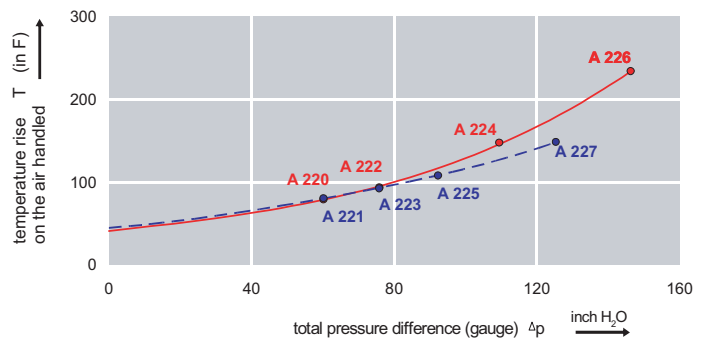
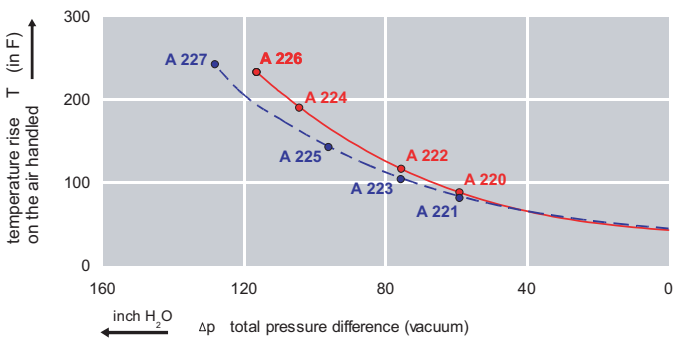
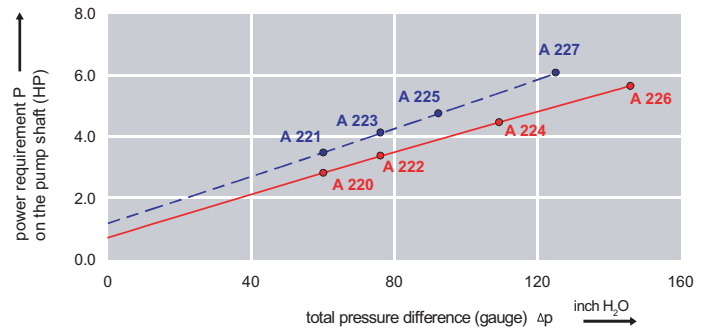
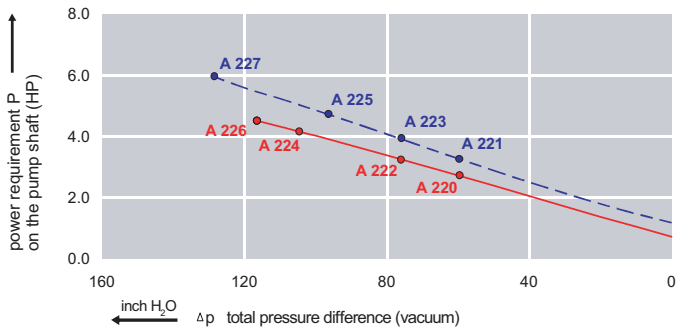
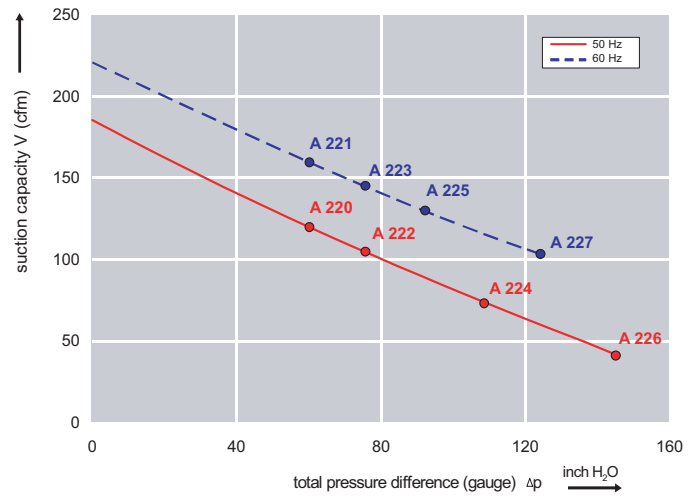

Dimensions: (inches)

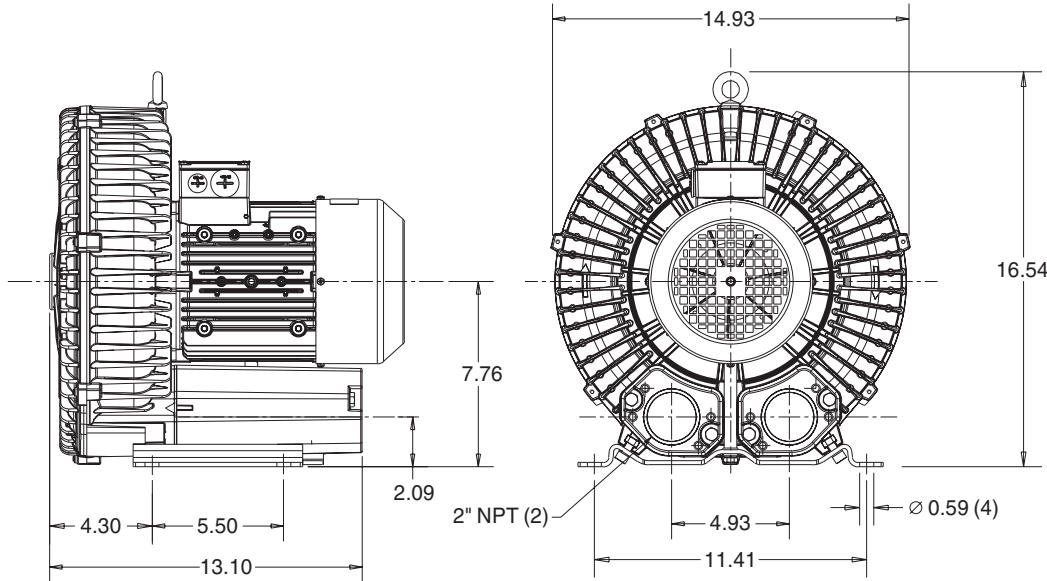

Recommended Accessories:

Relief valve:

VC61Z (Vacuum)
PC61Z (Pressure)

Filter:

ATF-200-15124/1
(Vacuum)
AFS-30-200-10
(Pressure)

Specifications subject to change without notice. Please contact factory for specification updates.

Selection & Ordering Data - Type 3BA1600

Curve No.	Order No.	Fre- quency Hz	Rated power HP	Input voltage		Input current		Permissible total differential pressure		Sound pressure level dB(A)	Weig lbs
				V		A		Vacuum inch H2O	Compressor inch H2O		
3~ 50/60 Hz IP55 insulation material class F											
A 220	3BA1600-7AT06	50	2.15	200D ... 240D	345Y ... 415Y	8.5D	4.9Y	-64	60	69	57
A 221	3BA1600-7AT06	60	2.7	220D ... 250D	415Y ... 460Y	7.5D	4.4Y	-64	60	72	57
A 222	3BA1600-7AT16	50	2.95	200D ... 240D	345Y ... 415Y	10.0D	5.8Y	-85	70	70	64
A 223	3BA1600-7AT16	60	3.42	220D ... 250D	415Y ... 460Y	10.3D	6.5Y	-85	76	73	64
A 224	3BA1600-7AT26	50	4.02	200D ... 240D	345Y ... 415Y	12.5D	7.2Y	-104	108	70	75
A 225	3BA1600-7AT26	60	4.62	220D ... 250D	415Y ... 460Y	12.0D	6.5Y	-96	92	73	75
A 226	3BA1600-7AT36	50	5.36	200D ... 240D	345Y ... 415Y	13.0D	7.5Y	-116	145	70	93
A 227	3BA1600-7AT36	60	6.16	220D ... 250D	415Y ... 460Y	15.2D	8.5Y	-128	124	73	93

Suitable for 208 Volt Operation

All curves are rated at 14.7 psia and 68°F ambient conditions and are reported in SCFM referenced to 68°F and 14.696 psia sea level conditions. Curve values are nominal, actual performance may vary by up to 10% of the values indicated. For inlet temperatures above approximately 80°F or for handling gases other than air, please contact your Airtech sales representative for assistance.